

Article number: 201134101

Description: E+G Guide bush DIN 172-B20-20-A
with collar

Measures

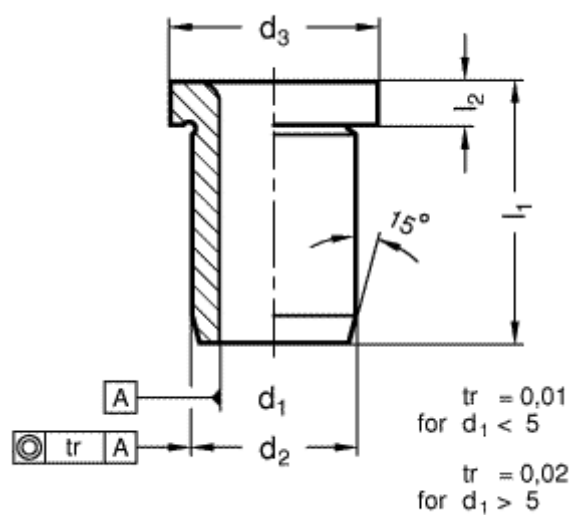

d1 = 22

d2 = 30

d3 = 34

l1 = 20

l2 = 5